



# High Definition Television Receiver

## OWNER'S MANUAL

MODEL : LST-5100P



Before connecting, operating or adjusting this product,  
please read this owner's manual carefully and completely.

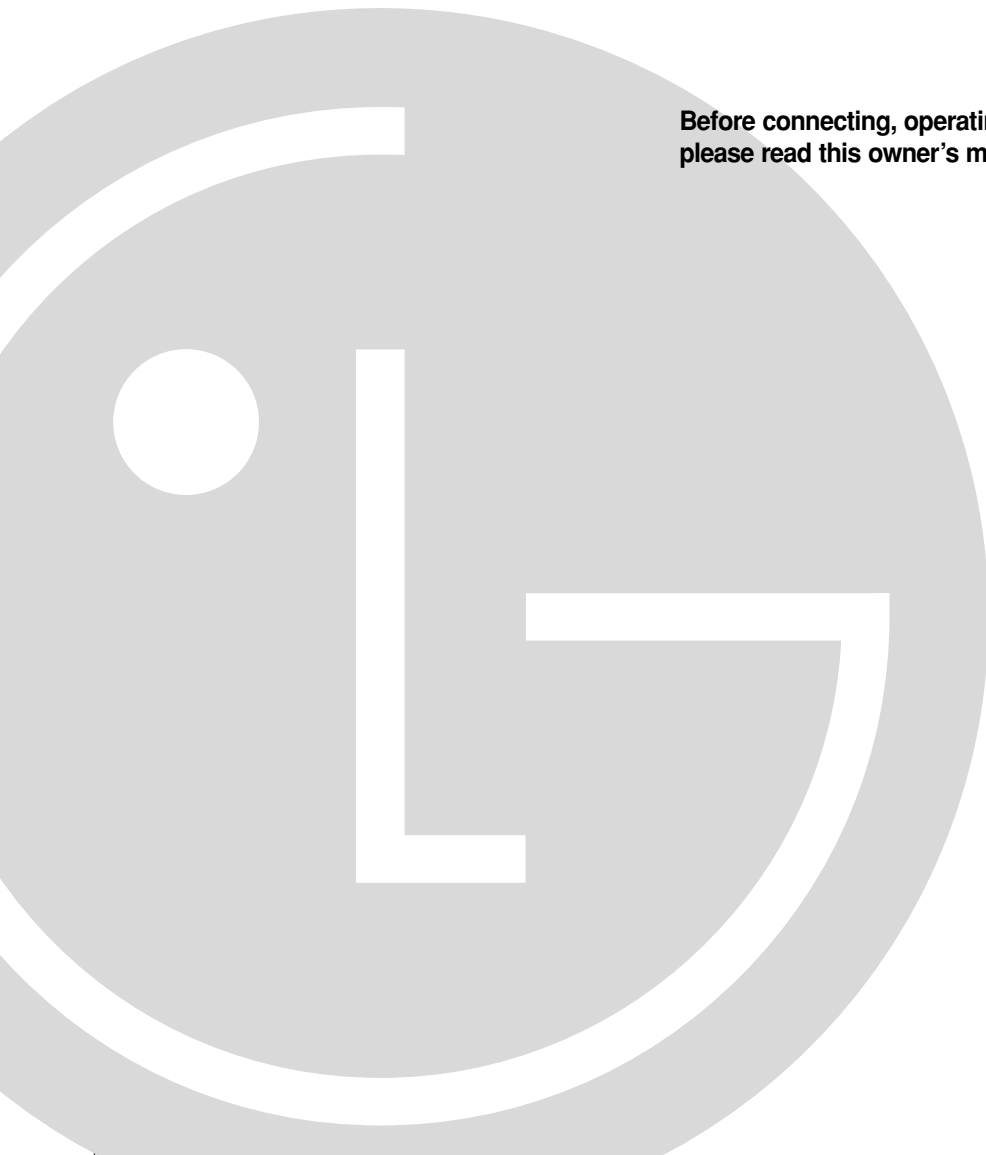

## Safety Precautions



**CAUTION**  
RISK OF ELECTRIC SHOCK  
DO NOT OPEN



### **CAUTION:**

TO REDUCE THE RISK OF ELECTRIC SHOCK DO NOT REMOVE COVER (OR BACK). NO USER SERVICEABLE PARTS INSIDE. REFER TO QUALIFIED SERVICE PERSONNEL.



THE LIGHTNING FLASH WITH ARROWHEAD SYMBOL, WITHIN AN EQUILATERAL TRIANGLE, IS INTENDED TO ALERT THE USER TO THE PRESENCE OF UNINSULATED "DANGEROUS VOLTAGE" WITHIN THE PRODUCT'S ENCLOSURE THAT MAY BE OF SUFFICIENT MAGNITUDE TO CONSTITUTE A RISK OF ELECTRIC SHOCK TO PERSONS.



THE EXCLAMATION POINT WITHIN AN EQUILATERAL TRIANGLE IS INTENDED TO ALERT THE USER TO THE PRESENCE OF IMPORTANT OPERATING AND MAINTENANCE (SERVICING) INSTRUCTIONS IN THE LITERATURE ACCOMPANYING THE APPLIANCE.

### **WARNING**

TO PREVENT FIRE OR SHOCK HAZARDS, DO NOT EXPOSE THIS PRODUCT TO RAIN OR MOISTURE.

The apparatus shall not be exposed to dripping or splashing and that no objects filled with liquids, such as vases, shall be placed on the apparatus.

**WARNING:** Do not install this equipment in a confined space such as a book case or similar unit.

**CAUTION:** TO PREVENT ELECTRIC SHOCK, MATCH WIDE BLADE OF PLUG TO WIDE SLOT AND FULLY INSERT.

### **CAUTION**

DO NOT ATTEMPT TO MODIFY THIS PRODUCT IN ANY WAY WITHOUT WRITTEN AUTHORIZATION FROM LG ELECTRONICS CORPORATION. UNAUTHORIZED MODIFICATION COULD VOID THE USER'S AUTHORITY TO OPERATE THIS PRODUCT.

THIS EQUIPMENT IS INTENDED TO RECEIVE AND DECODE SIGNALS TRANSMITTED ACCORDING TO DVB AND IS INTENDED TO BE USED WITH AN APPROPRIATE ANTENNA AND DISPLAY DEVICE THAT YOU MUST PROVIDE.

### **CAUTION:**

- The appliance is not intended for use by young children or infirm persons without supervision.
- Young Children should be supervised to ensure that they do not play with appliance.
- If the appliance is supplied from a cord extension set or an electrical portable outlet device, the cord extension set on electrical portable outlet device must be positioned so that it is not subject to splashing or ingress of moisture.

# IMPORTANT SAFETY INSTRUCTIONS

**CAUTION: PLEASE READ AND OBSERVE ALL WARNINGS AND INSTRUCTIONS IN THIS INSTALLATION AND OPERATING GUIDE AND THOSE MARKED ON THE UNIT. RETAIN THIS GUIDE FOR FUTURE REFERENCE.**

This set has been designed and manufactured to assure personal safety. Improper use can result in electric shock or fire hazard. The safeguards incorporated in this unit will protect you if you observe the following procedures for installation, use, and servicing.

This unit does not contain any parts that can be repaired by the user.

**DO NOT REMOVE THE CABINET COVER, OR YOU MAY BE EXPOSED TO DANGEROUS VOLTAGE. REFER SERVICING TO QUALIFIED SERVICE PERSONNEL ONLY.**

- 1. Read these instructions.** - All these safety and operating instructions should be read before the product is operated.
- 2. Keep these instructions.** - The safety, operating and use instructions should be retained for future reference.
- 3. Heed all warnings.** - All warnings on the product and in the operating instructions should be adhered to.
- 4. Follow all instructions.** - All operating and use instructions should be followed.
- 5. Do not use this apparatus near water.** - For example: near a bath tub, wash bowl, kitchen sink, laundry tub, in a wet basement; near a swimming pool; etc.
- 6. Clean only with dry cloth.** - Unplug this product from the wall outlet before cleaning. Do not use liquid cleaners.
- 7. Do not block any ventilation openings. Install in accordance with the manufacturer's instructions.** - Slots and openings in the cabinet are provided for ventilation, to ensure reliable operation of the product, and to protect it from over-heating. The openings should never be blocked by placing the product on a bed, sofa, rug or other similar surface. This product should not be placed in a built-in installation such as a bookcase or rack unless proper ventilation is provided and the manufacturer's instructions have been adhered to.
- 8. Do not install near any heat sources such as radiators, heat registers, stoves, or other apparatus (including amplifiers) that produce heat.**
- 9. Do not defeat the safety purpose of the polarized or grounding-type plug.** A polarized plug has two blades with one wider than the other. A grounding type plug has two blades and a third grounding prong. The wide blade or the third prong are provided for your safety. If the provided plug does not fit into your outlet, consult an electrician for replacement of the obsolete outlet.
- 10. Protect the power cord from being walked on or pinched particularly at plugs, convenience receptacles, and the point where they exit from the apparatus.**
- 11. Only use attachments/accessories specified by the manufacturer.**
- 12. Use only the cart, stand, tripod, bracket, or table specified by the manufacturer, or sold with apparatus. When a cart is used, use caution when moving the cart/ apparatus combination to avoid injury from tip-over.**
- 13. Unplug this apparatus during lightning storms or when unused for long periods of time.**
- 14. Refer all servicing to qualified service personnel. Servicing is required when the apparatus has been damaged in any way, such as power-supply cord or plug is damaged, liquid has been spilled or objects have fallen into the apparatus, the apparatus has been exposed to rain or moisture, does not operate normally, or has been dropped.**



## Table of Contents

### INTRODUCTION

Safety Precautions .....	2
<b>IMPORTANT SAFETY INSTRUCTIONS</b> .....	<b>3</b>
<b>Table of Contents</b> .....	<b>4</b>
<b>Front Panel Controls and Display Window</b> .....	<b>5</b>
<b>Remote Control Key Functions</b> .....	<b>6</b>
<b>Unpacking HDTV Receiver and Accessories/Connection Overview</b> .....	<b>7</b>
<b>Connection Panel Overview</b> .....	<b>8</b>

### INSTALLATION

<b>Connections</b> .....	<b>9-15</b>
Antenna Connections .....	9
Analog Monitor Connections .....	10
HD Monitor Component (YPbPr) Connections ..	11
HD Monitor RGB Connections .....	12
HD Monitor DVI-HDTV Connections .....	13
VCR Connections .....	14
Amplifier (Receiver) Connections .....	15
<b>Setting the Display Format</b> .....	<b>16</b>

### MENU OPERATION

<b>Initial Settings</b> .....	<b>17</b>
General Operation .....	17
<b>Setup Menu Options</b> .....	<b>18-19</b>
Initial Settings .....	17
Auto Programme .....	18
Programme Edit .....	18
Signal Strength .....	19
<b>Audio Menu Options</b> .....	<b>20-21</b>
Audio Option .....	20
Digital Audio Output .....	20
Audio Variable .....	21
<b>Special Menu Options</b> .....	<b>22-23</b>
Aspect Ratio .....	22
Clock Set .....	23
Caption .....	23
<b>Lock (Parental Control) Menu Options</b> .....	<b>24-26</b>
Lock System .....	24
Change PIN .....	24
Block Programme .....	25
Parental Guidance .....	26

### NORMAL OPERATION

<b>Information Displays</b> .....	<b>27-28</b>
Programme Banner Display .....	27
Programme Information Display .....	28
<b>Programme Guide</b> .....	<b>29</b>
<b>Normal Operation</b> .....	<b>30</b>
Programme Selection .....	30
Volume Adjustment .....	30
Signal .....	30
<b>Teletext Operation</b> .....	<b>31-32</b>

### REFERENCE

<b>Programming the Remote Control to Operate the TV</b> .....	<b>33</b>
<b>Remote Control Codes for TVs</b> .....	<b>34-35</b>
<b>Troubleshooting</b> .....	<b>36</b>
<b>Specifications</b> .....	<b>37</b>

### About the symbols for instructions

 Indicates hazards likely to cause harm to the unit itself or other material damage.

 Indicates special operating features of this unit.

 Indicates tips and hints for making the task easier.

Manufactured under license from Dolby Laboratories. Dolby, and the double-D symbol are trademarks of Dolby Laboratories. Confidential unpublished works. Copyright 1992-1997 Dolby Laboratories. All rights reserved.

## Front Panel Controls and Display Window

### Arrow Buttons (▲ / ▼ / ◀ / ▶)

Allow you to navigate on-screen menus and to adjust the system settings and preferences. Use the arrow keys to move to a menu option and then use the **⊙** (SELECT) button to access it. If no menu is displayed, the LEFT/RIGHT arrows control the volume setting and the UP/DOWN arrows select programmes.

### POWER

Turns the HDTV Receiver on or off.

### Remote Control Sensor

Receives signals from the remote control.

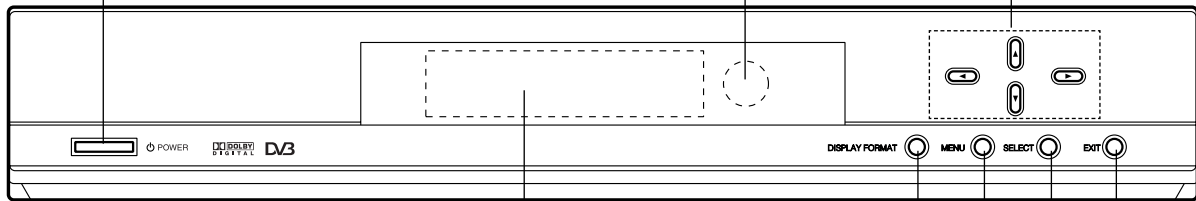

### Display Window

### DISPLAY FORMAT

Sets the output resolution to formats and chooses the correct display format for your TV.

### MENU

Shows the main menu on the screen. You can return to normal viewing by pressing the EXIT button.

### SELECT

If the main menu is displayed, pressing the **⊙** (SELECT) button will activate the selected MENU option. If the **⊙** (SELECT) button is pressed while you are in normal viewing, the Programme Banner will be displayed.

### EXIT

Clears all on-screen displays and returns to normal viewing from any menu.

### Resolution Indicator

Indicates output resolution.

### Connection Indicator

Indicates output connection.

### Standby Indicator

Lights when the HDTV Receiver is turned off.

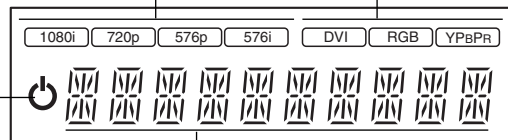

### Character Indicators

Indicates programme number, volume level, etc.

## Remote Control Key Functions

- POWER**  
Turns the HDTV Receiver ON and OFF.
- Numbers**  
Chooses programmes and enters programming information.
- PREV.**  
Turns to the previous programme.
- AUDIO**  
Selects programme's audio language options if available.
- CC**  
Selects caption mode if available.
- ARC**  
Changes the picture aspect ratio.
- SIGNAL**  
Shows the signal strength of the current programme.
- MENU**  
Accesses or closes main menu.
- MUTE**  
Pauses the audio temporarily. That is, volumes on/off temporarily.
- COLOR Buttons**  
It's for teletext application. Pressing RED or GREEN buttons pages through the Programme Guide menu.
- TEXT**  
Switches between teletext mode and normal TV viewing.
- MIX**  
Selects the background for teletext screen (Opaque, User Transparency, Transparency).
- CANCEL**  
Hides the teletext screen except page number.
- INDEX**  
Moves to Index screen. If Index page is not present, moves to page 100.

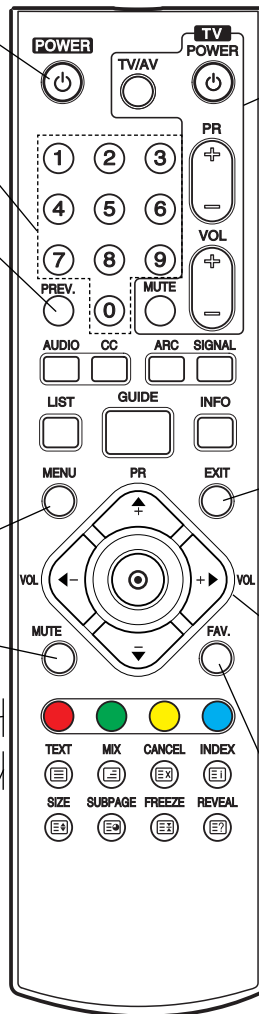

### TV Control Buttons

- POWER: Turns the TV on or off.
- TV/AV: Selects the TV's source.
- PR +/-: Selects TV's programme.
- VOL +/-: Adjusts TV's volume.
- MUTE: Temporarily turns TV sound OFF, press again to restore.

### LIST

Displays the programme list.

### GUIDE

Displays the Programme Guide.

### INFO

Shows the current station and programme information on the screen.

### EXIT

Removes all on-screen displays and returns to TV viewing from any menu.

### ARROW Buttons (▲ / ▼ / ◀ / ▶)

Selects options in a menu.

### VOL +/-

Changes volume.

### PR +/-

Selects a memorized programmes. Pressing these buttons pages through the Teletext menu.

### ⊙ (SELECT)

Completes the programme number input and promptly tunes to selected programme.

### FAV.

Changes to the favorite programme.

### SIZE

Enlarges the text size to double in the teletext mode.

### SUBPAGE

Searches the sub-page using the sub-code.

### FREEZE

Freezes the current image during TV viewing. Pressing the button again returns the image to live video. Holds the teletext display and stops the automatic page change in the teletext mode.

### REVEAL

Displays concealed information.

# Unpacking HDTV Receiver and Accessories/Connection Overview

Make sure you have received all the accessories listed below with the High Definition Television Receiver.

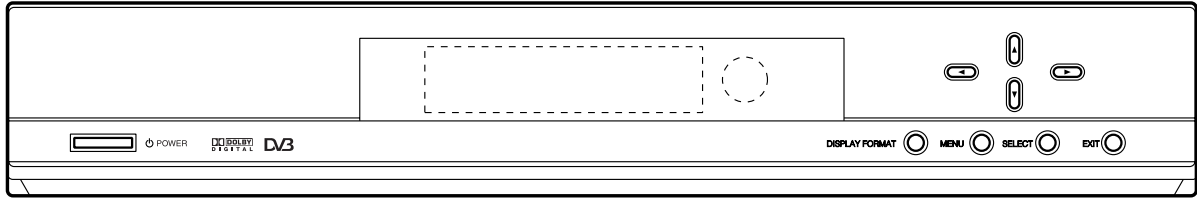

## High Definition Television Receiver

The HDTV Receiver is capable of receiving signals from over-the-air antenna sources and sending the signals to your TV.

Included with the Receiver are the following accessories.

- |                         |                 |
|-------------------------|-----------------|
| Audio Cable             | Video Cable     |
| Component (YPbPr) Cable | RF Cable        |
| Remote Control          | 2 AAA Batteries |

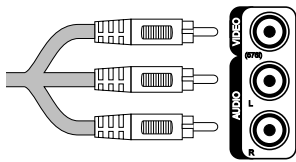

### Audio/Video Jacks and Cables

The Audio/Video jacks provide excellent picture and sound quality. They are used for making most Audio/Video connections between components. The Audio/Video jacks may be color coded (yellow for video, red for right audio, and white for left audio). If your component has only one input for audio (mono), connect it to the left (white L/mono) audio jack on the HDTV Receiver.

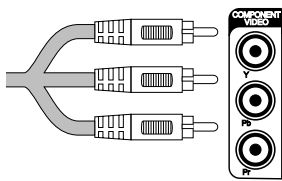

### Component Out Jacks and Cables

Component Cables are used to connect the HDTV Receiver to an industry standard YPbPr compatible HD Monitor (green for Y, blue for Pb, and red for Pr). Remember to connect the left and right audio cables. The YPbPr Component jacks carry only the picture signals, not the sound.

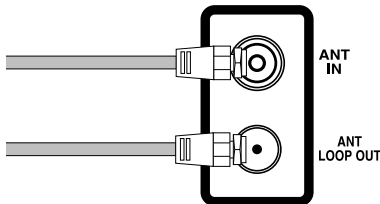

### ANT LOOP OUT Jack, and RF Cable

ANT LOOP OUT provides an RF connection between the HDTV Receiver and the TV and provides the signal of ANT IN jack to TV.

### Remote Control

In addition to the HDTV Receiver, the remote control can be programmed to control many other devices.

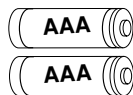
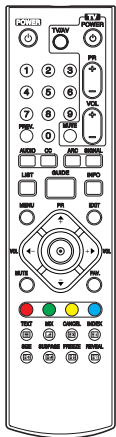



### Remote Control Operation Range

Point the remote control at the remote sensor and press the buttons.

- **Distance:** About 7 m from the front of the remote sensor.
- **Angle:** About 30° in each direction of the front of the remote sensor.

### Remote Control Battery Installation

Remove the battery cover on the rear of the remote control, and insert two batteries (size AAA) with  and  aligned correctly. Reinstall cover.

### Caution

Do not mix old and new batteries. Never mix different types of batteries (standard, alkaline, etc.).

## Connection Panel Overview

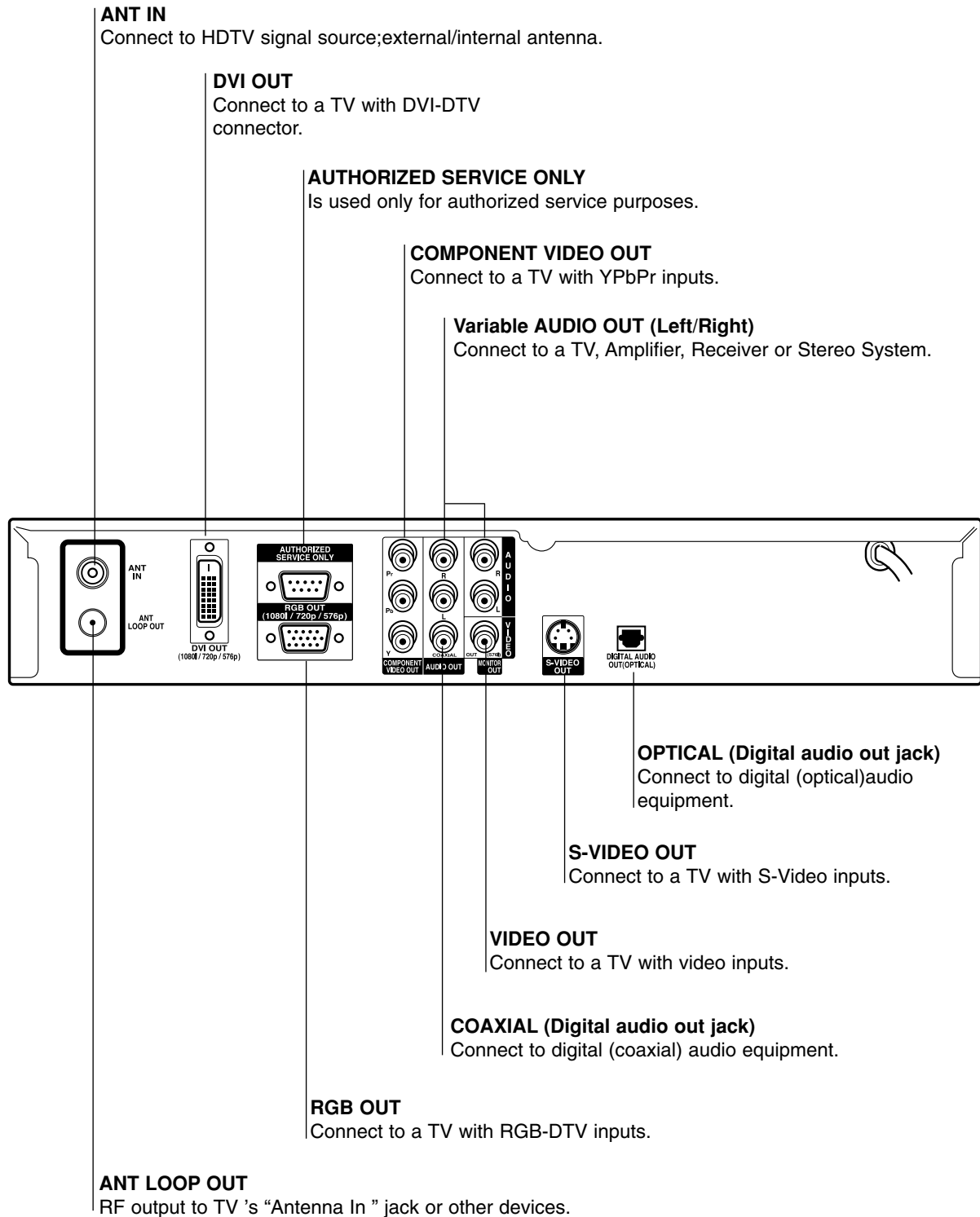

**Do not touch the inner pins of the jacks on the rear panel.**  
Electrostatic discharge may cause permanent damage to the unit.



## Connections

### Antenna Connections

- 1 Connect the "Antenna" to the "ANT IN" jack on the HDTV Receiver using a coaxial RF cable.

#### Note

There might be some areas where the signal strength could be too high. If so, you may need to connect the antenna to an attenuator. Screw the attenuator onto the "ANT IN" jack.

- 2 Connect the "ANT LOOP OUT" jack on the HDTV Receiver to the "Antenna In" jack on your TV using a coaxial RF cable.

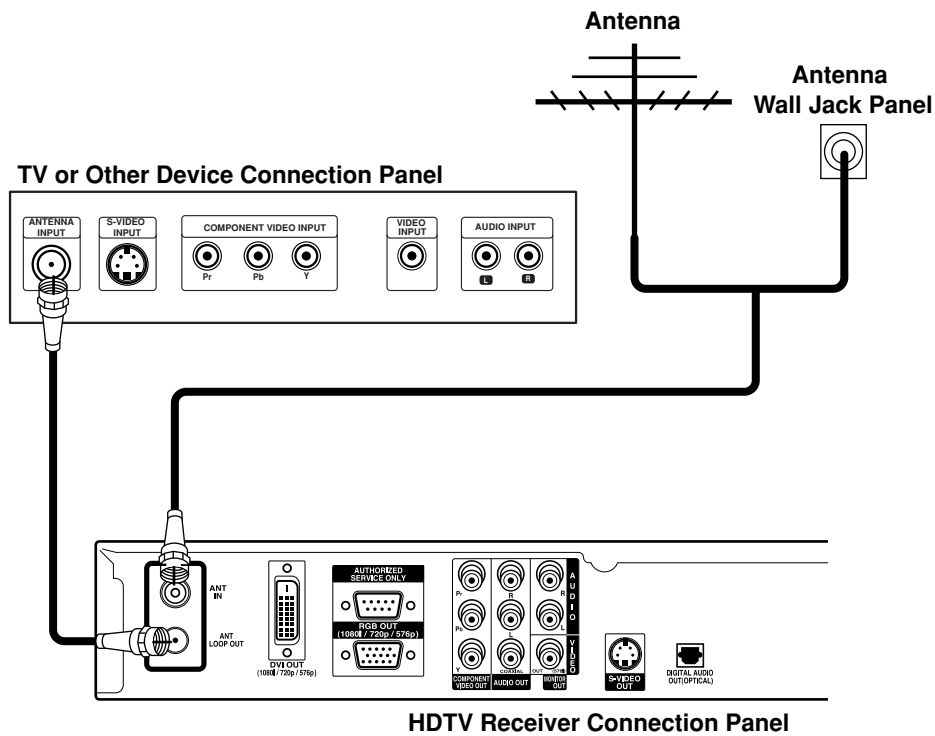

## Connections (Continued)

### Display Formats Overview

- The HDTV Receiver offers various display formats and multiple video outputs. When the HDTV Tuner is connected to A/V systems, the HDTV Tuner can provide video signal formats 1080i, 720p, 576p, and 576i.
- 1080i, 720p, 576p, and 576i modes are available for component video (YPbPr) outputs.
- 1080i, 720p, and 576p modes are available for RGB and DVI outputs.
- 576i mode is available for VIDEO, S-VIDEO, and COMPONENT VIDEO outputs.
- The HDTV Tuner has two digital audio outputs; Dolby Digital 5.1 and PCM. The HDTV Tuner sends out a digital audio signal to OPTICAL and COAXIAL audio outputs when digital broadcasts are being received by the HDTV Tuner.

### Analog Monitor Connections

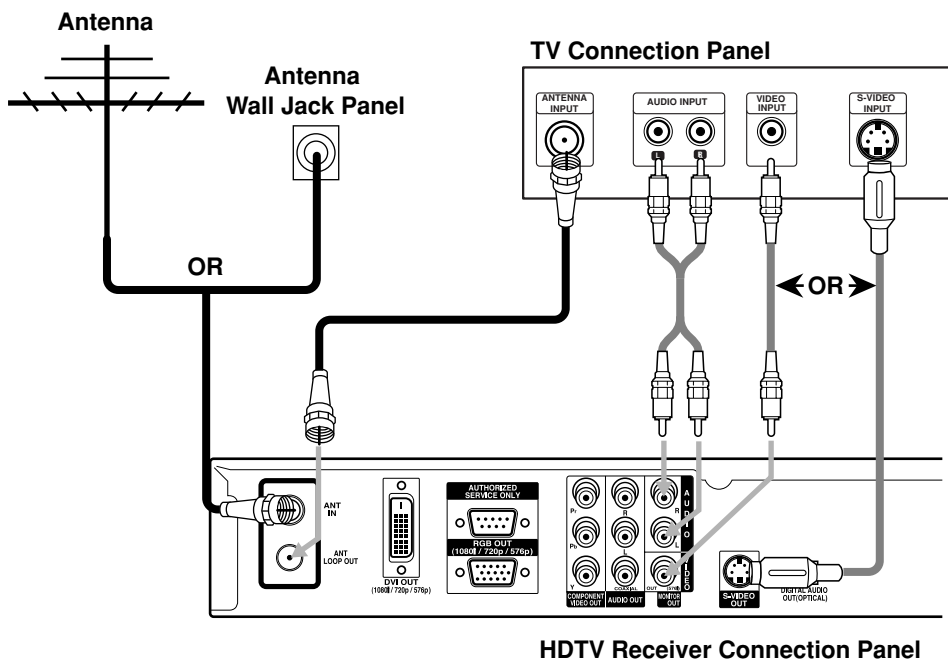

**1** Connect the “Antenna” to the “ANT IN” jack on the HDTV Receiver using a coaxial RF cable.

#### Note

There might be some areas where the signal strength could be too high. If so, you may need to connect the antenna to an attenuator. Screw the attenuator onto the “ANT IN” jack. (Refer to page 9.)

**2** Connect the “ANT LOOP OUT” jack on the HDTV Receiver to the “Antenna In” jack on your TV using a coaxial RF cable.

**3** Connect the “AUDIO OUT” and “VIDEO OUT” jacks on the HDTV Receiver to the “A/V IN” jacks on your TV using RCA-type cables. If your TV is equipped with an S-Video jack, use the S-VIDEO OUT jack. (The Output Selection must be set to YPbPr, refer to Display Format Setup on page 16.)

#### Note

When using Composite VIDEO OUT (yellow connector) or S-video outputs from HDTV Receiver, MENU will only appear and operate if 576i format is selected.

## Connections (Continued)

### HD Monitor Component (YPbPr) Connections

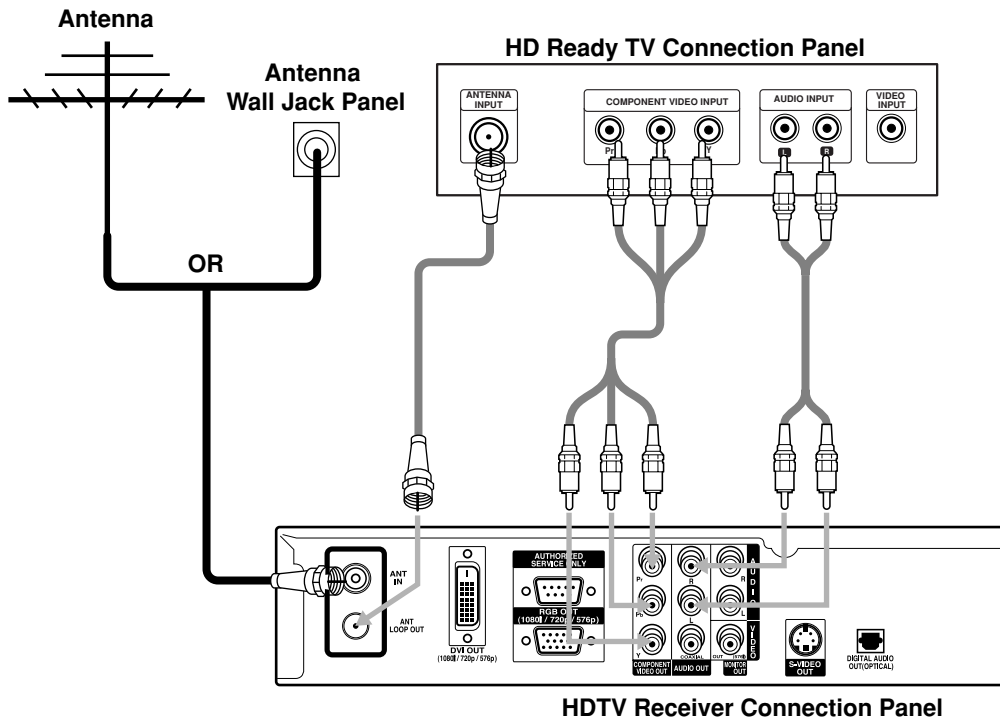

**1** Connect the “Antenna” to the “ANT IN” jack on the HDTV Receiver using a coaxial RF cable.

#### **Note**

There might be some areas where the signal strength could be too high. If so, you may need to connect the antenna to an attenuator. Screw the attenuator onto the “ANT IN” jack. (Refer to page 9.)

**2** Connect the “ANT LOOP OUT” jack on the HDTV Receiver to the “Antenna In” jack on your TV using a coaxial RF cable.

**3** Connect the “COMPONENT OUT” jacks on the HDTV Receiver to the “COMPONENT IN” jacks of your TV using RCA-type cables. (The Output Selection must be set to YPbPr, refer to Display Format Setup on page 16.)

**4** Connect the L/R “AUDIO OUT” jacks on the HDTV Receiver to the L/R “AUDIO IN” jacks on your TV using RCA-type cables.

#### **Note**

1080i, 720p, 576p, and 576i modes are available for component video (YPbPr) outputs.

## Connections (Continued)

### HD Monitor RGB Connections

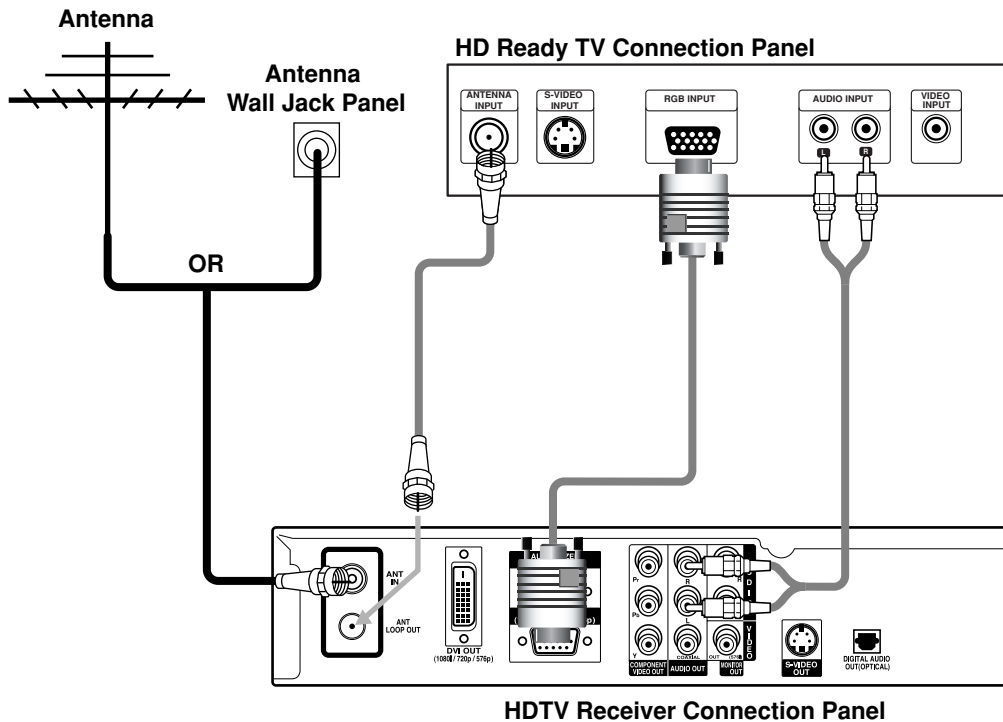

- 1 Connect the "Antenna" to the "ANT IN" jack on the HDTV Receiver using a coaxial RF cable.

#### Note

There might be some areas where the signal strength could be too high. If so, you may need to connect the antenna to an attenuator. Screw the attenuator onto the "ANT IN" jack. (Refer to page 9.)

- 2 Connect the "ANT LOOP OUT" jack on the HDTV Receiver to the "Antenna In" jack on your TV using a coaxial RF cable.
- 3 Connect the "RGB OUT" jack on the HDTV Receiver to the "RGB IN for DTV" jack of your TV using VGA-type connector. (The Output Selection must be set to RGB, refer to Display Format Setup on page 16.)
- 4 Connect the L/R "AUDIO OUT" jacks on the HDTV Receiver to the L/R "AUDIO IN" jacks on your TV using RCA-type cables.

#### Note

1080i, 720p, and 576p modes are available for RGB outputs.

## Connections (Continued)

### HD Monitor DVI-HDTV Connections

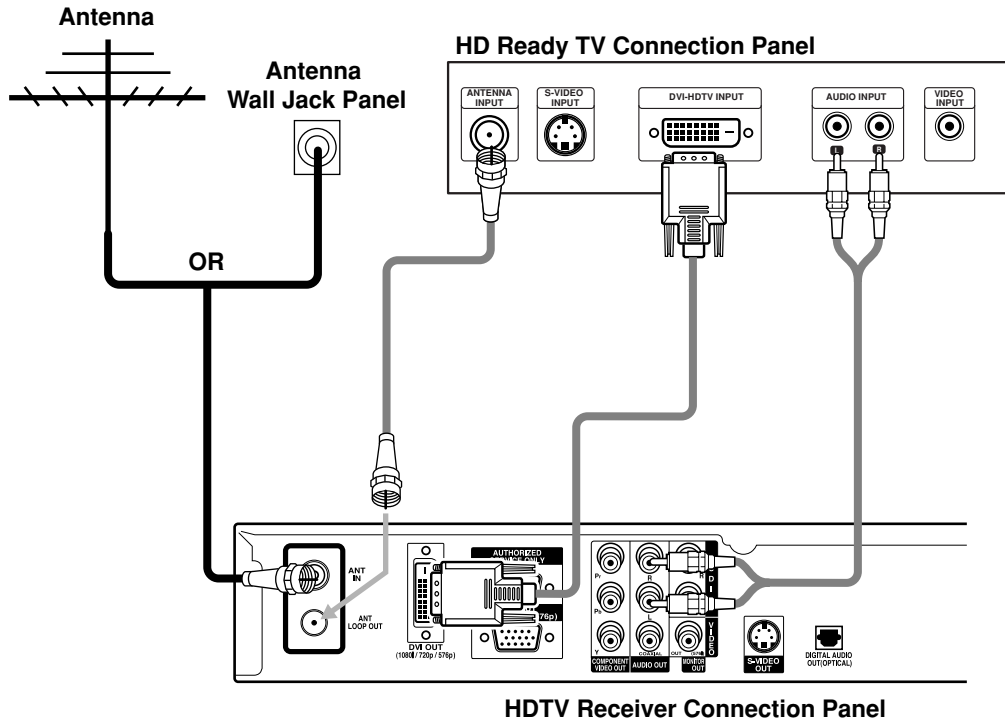

**1** Connect the “Antenna” to the “ANT IN” jack on the HDTV Receiver using a coaxial RF cable.

**Note**

There might be some areas where the signal strength could be too high. If so, you may need to connect the antenna to an attenuator. Screw the attenuator onto the “ANT IN” jack. (Refer to page 9.)

**2** Connect the “ANT LOOP OUT” jack on the HDTV Receiver to the “Antenna In” jack on your TV using a coaxial RF cable.

**3** Connect the “DVI OUT” jack on the HDTV Receiver to the “DVI IN for DTV” jack of your TV using DVI-D type connector. (The Output Selection must be set to DVI, refer to Display Format Setup on page 16.)

**4** Connect the L/R “AUDIO OUT” jacks on the HDTV Receiver to the L/R “AUDIO IN” jacks on your TV using RCA-type cables.

**Note**

- 1080i, 720p, and 576p modes are available for DVI outputs.
- A DVI-HDTV input is one that is compliant with EIA-861 specifications. Check your TV or monitor's user manual to find out if the TV or monitor's DVI input is compliant with these specifications.
- Some HD Monitors designed for PC applications using DVI-D may not work with this connection.

## Connections (Continued)

### VCR Connections

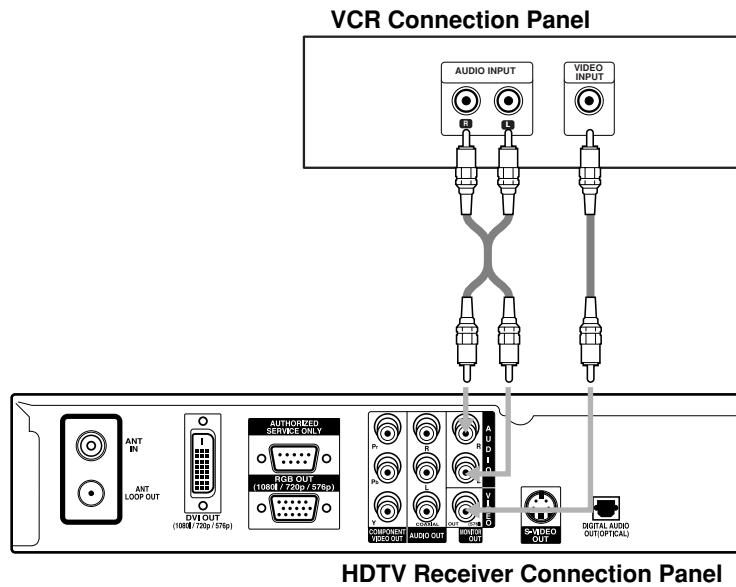

Connect the L/R “AUDIO OUT” jacks and “VIDEO OUT” jack on the HDTV Receiver to the “A/V in” jacks on your VCR using RCA-type cables. (If your VCR is equipped with an S-Video jack, use the “S-Video” jack.)



#### Caution

**If the Output Selection is set to YPbPr and 576i display format is selected, the VCR will record an onscreen display onto the tape during recording if:**

- the programme is changed with PR (+/-)
- the sound level is adjusted with VOL (+/-)
- or by pressing the (SELECT) button, etc.



#### Note

The caption signal is recorded when the display format settings are set to 576i. (Refer to page 16.)

## Connections (Continued)

### Amplifier (Receiver) Connections

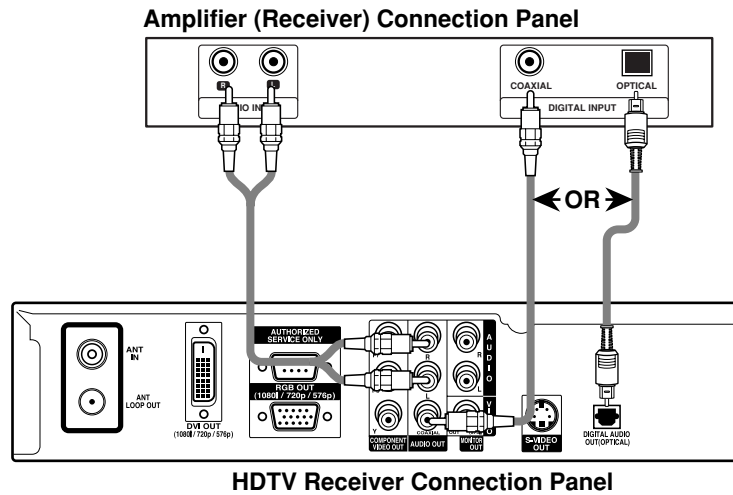

#### Connecting to an amplifier equipped with two channel analog stereo or Dolby Surround

Connect the Left and Right AUDIO OUT jacks on the HDTV Receiver to the audio left and right in jacks on your amplifier, receiver, or stereo system, using the supplied audio cables.

#### Connecting to an amplifier equipped with two channel digital stereo (PCM) or to an Audio/ Video receiver equipped with a multi-channel decoder (Dolby Digital™)

Connect one of the HDTV Receiver's DIGITAL AUDIO OUT jacks (OPTICAL or COAXIAL) to the corresponding input jack on your amplifier. Use an optional digital (optical or coaxial) audio cable.

#### Digital Multi-channel sound

A digital multi-channel connection provides the best sound quality. For this you need a multi-channel Audio/Video receiver that supports one or more of the audio formats supported by your HDTV Receiver (Dolby Digital). Check the receiver manual and the logos on the front of the receiver.

## Setting the Display Format

The HDTV Receiver provides several display formats. The DISPLAY FORMAT button on the front panel changes the output resolution. The output resolution may be converted from the original broadcast format.

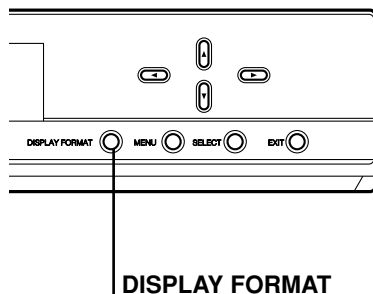

### Display Format Setup

- 1** Press **DISPLAY FORMAT** once on the front panel.  
The current output signal will appear in the display window.
- 2** Depending on the type of Monitor that the HDTV Receiver is connected to, press **DISPLAY FORMAT** or **◀/▶** repeatedly on the front panel to select desired output connector. (YPbPr, RGB, or DVI.)  
Press **MENU** button if you wish to exit the display format setting.
- 3** Use **SELECT** on the front panel to confirm your output connector selection.  
The current output resolution will appear in the display window.
- 4** Depending on the type of Monitor that the HDTV Receiver is connected to, press **DISPLAY FORMAT** or **◀/▶** repeatedly on the front panel to select desired output resolution. (1080i, 720p, 576p, 576i)  
Press **MENU** button if you wish to return to the output connector setting mode.
- 5** Press **⊙** (**SELECT**) on the front panel to confirm your output resolution selection.  
Display Format setup is finished.

#### **N**otes

- You can exit Display Format Setup mode by pressing **EXIT** on the front panel.
- The **S-VIDEO** and **VIDEO OUT** jacks' signals are converted from all formats to 576i format.
- When using Composite video or S-video outputs from HDTV Receiver, on-screen display will only appear and operate if 576i format is selected.

Display Format modes	Input Signal format	Output Signal format
1080i	all formats	1080i
720p	all formats	720p
576p	all formats	576p
576i	all formats	576i

OUTPUT CONNECTION	AVAILABLE FORMATS
COMPONENT VIDEO OUT	1080i/720p/576p/576i
RGB OUT	1080i/720p/576p
DVI OUT	1080i/720p/576p
VIDEO OUT	All formats converted to 576i
S-VIDEO OUT	All formats converted to 576i



## Initial Settings

In this menu system, there are several ways to customize the settings provided. Most menus consist of three levels to set up the options, but some require greater depth for the variety of settings. If you press the MENU button, only the first and second level of the menu system will appear on the TV screen. The third level can be displayed by pressing **⊙** (SELECT). If a menu has more than three levels, the pop-up dialogue box will be displayed as the fourth or fifth level. For navigating the menu levels, you will see “▶” on the right side of the menu label to help you go to the next level.

### To show and remove the Menu:

Press the MENU button on the remote control to display the menu. A second press of the MENU button or a press of the EXIT button will take you back to TV viewing.



### To go to the next level:

Press “**⊙** (SELECT)” (or “▶”) on the remote control.

### To go back to the previous level:

Press MENU (or “◀”) on the remote control.

## General Operation

- 1 Press MENU.**  
The main menu will appear.
- 2 Use ▲ / ▼ to select the desired menu option.**
- 3 While the desired menu option is selected, press ▶ or ⊙ (SELECT) to move to the second level.**
- 4 Use ▲ / ▼ to select the second menu option.**
- 5 Press ▶ or ⊙ (SELECT) to move to the third level.**  
Some menu options require additional steps.
- 6 Press MENU to return to the previous menu or press EXIT on the remote control to return to TV viewing.**

### Note

If your TV is in zoom mode, the menu screen may be cut off. In this case, set the TV's zoom mode to normal to display the menu properly.

## Setup Menu Options

### Note

PIN is needed to access the SETUP menu if [Lock System] option is set to [On].

### Auto Programme

Automatically finds all programmes (digital), and stores all the active programmes found on the programme list. Inactive or weak programmes may not appear on the list.



- 1 Press MENU to display the on-screen menu.
- 2 Select the SETUP menu using ▲ / ▼ then press Ⓞ (SELECT) or ► to move to the second level.
- 3 Select the Auto Programme using ▲ / ▼ then press Ⓞ (SELECT) or ► to move to the third level.
- 4 Select the "1.DTV" using ▲ / ▼ then press Ⓞ (SELECT). The programme search process begins. You can stop the process by pressing Ⓞ (SELECT), MENU or EXIT.
- 5 When programme search is complete, the lowest programme number found appears on the TV screen.

### Programme Edit

Programme Edit allows you to add or skip programmes from the programme list in memory manually and create your own favorite list of favorite programmes.



- 1 Press MENU to display the on-screen menu.
- 2 Select the SETUP menu using ▲ / ▼ then press Ⓞ (SELECT) or ► to move to the second level.
- 3 Select the Programme Edit using ▲ / ▼ then press Ⓞ (SELECT) or ►. Programme Edit menu appears.

#### To skip a programme

Select a programme on the programme editing menu then press blue button to skip the programme. The skipped programme number will dim. When a programme number is skipped it means that you will be unable to select it using the PR (+/-) button during normal TV viewing. If you want to select the skipped programme, directly enter the programme number with the number buttons or select it in the Programme List menu.

#### To block a programme

Select a programme on the programme editing menu then press yellow button to block the programme. (See page 25 for more details.)

#### To create a FAVOURITE LIST:

Select a programme on the programme editing menu then press FAV. to add the programme to the FAVOURITE LIST.

Only the programmes on the programme editing menu can be added to the surf list.

- 4 Press MENU to return to the previous screen or press EXIT on the remote control to return to TV viewing.

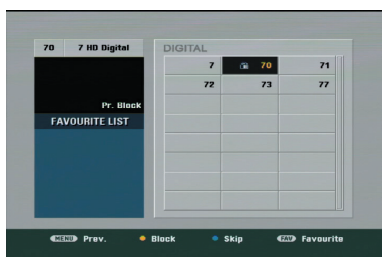

**Note:** If you access this menu when resolution is set to 576p, 720p, or 1080i, the VIDEO OUT and S-VIDEO OUT jacks' signals are blocked. Press EXIT button to restore the output signals.

## Setup Menu Options



### Note

PIN is needed to access the SETUP menu if [Lock System] option is set to [On].

### Signal Strength

Shows the strength bar for incoming signal to help you adjust the antenna to the correct position from your location.

- 1** Press MENU to display the on-screen menu.
- 2** Select the SETUP menu using ▲ / ▼ then press Ⓞ (SELECT) or ►.
- 3** Select the Signal Strength using ▲ / ▼.  
The signal strength bar will be displayed.
- 4** Press MENU to return to the previous screen or press EXIT on the remote control to return to TV viewing.

### Tip

You can also view signal strength bar by pressing SIGNAL on the remote control.

## Audio Menu Options

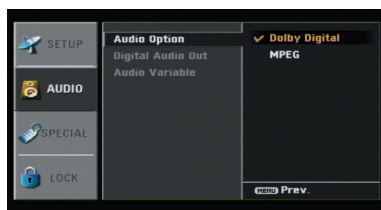

### Audio Option

The Audio Option allows you to select an audio stream for the TV programme being received.

- 1** Press MENU to display the on-screen menu.
- 2** Select the AUDIO menu using ▲ / ▼ then press Ⓞ (SELECT) or ►.
- 3** Select the Audio Option using ▲ / ▼ then press Ⓞ (SELECT) or ►.
- 4** Select the desired mode using ▲ / ▼.

**Dolby Digital:** Dolby Digital audio stream is received.

**MPEG:** MPEG audio stream is received.

- 5** Press MENU to return to the previous menu or press EXIT on the remote control to return to TV viewing.

#### Notes

- If the selected audio stream is not received, original audio stream will be automatically selected.
- You cannot change the "Audio Option" setting when the current programme's digital picture grade is SD (Standard Definition).

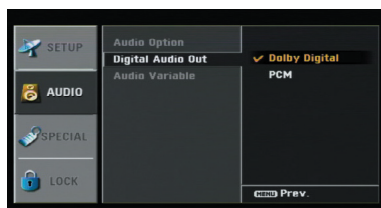

### Digital Audio Output

Sets the HDTV Receiver's digital Audio Output according to the type of audio system you use.

- 1** Press MENU to display the on-screen menu.
- 2** Select the AUDIO menu using ▲ / ▼ then press Ⓞ (SELECT) or ►.
- 3** Select the Digital Audio Out option using ▲ / ▼ then press Ⓞ (SELECT) or ►.
- 4** Select the desired audio output using ▲ / ▼.

**Dolby Digital:** Select "Dolby Digital" if you connected the HDTV Receiver's DIGITAL OUT jack to a Dolby Digital decoder (or an amplifier or other equipment with a Dolby Digital decoder).

**PCM:** Select when the HDTV Receiver's DIGITAL OUT jack is connected to a 2-channel digital stereo amplifier.

- 5** Press MENU to return to the previous menu or press EXIT on the remote control to return to TV viewing.

#### Notes

- If you select the "Dolby Digital" and current audio stream is not "Dolby Digital", the HDTV Receiver outputs the "PCM" signal from DIGITAL AUDIO OUT jacks (OPTICAL and COAXIAL).
- The "Digital Audio Out" is fixed to "PCM" when the "Audio Option" is set to "MPEG".
- You cannot change the "Digital Audio Out" setting when the current programme's digital picture grade is SD (Standard Definition).

## Audio Menu Options

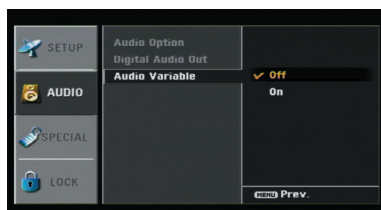

### Audio Variable

If the audio variable menu is set to On, audio volume can be increased/decreased with by pressing VOL (+/-) on the remote control or ◀/▶ on the front panel. If set to Off, audio volume can not be controlled by HDTV receiver.

- 1** Press MENU to display the on-screen menu.
- 2** Select the AUDIO menu using ▲ / ▼ then press Ⓞ (SELECT) or ▶.
- 3** Select Audio Variable using ▲ / ▼ then press Ⓞ (SELECT) or ▶.
- 4** Select an Audio Variable option (On or Off) using ▲ / ▼.
- 5** Press MENU to return to the previous menu or press EXIT on the remote control to return to TV viewing.

#### **N**otes

- Before setting the Audio Variable to Off, make sure that you have turned down the TV's volume to the minimum. Otherwise, sudden high volume sound may cause hearing or speaker damage.
- The volume of digital audio out on HDTV Receiver can not be adjusted on the HDTV Receiver.

## Special Menu Options



### Aspect Ratio

Lets you choose the screen format according to the screen ratio.

- 1** Press **MENU**.  
The main menu appears.
- 2** Use **▲ / ▼** to select the **SPECIAL** menu then press **▶** or **⊙** (**SELECT**) to move to the second level.
- 3** Use **▲ / ▼** to select the **Aspect Ratio** option.
- 4** Press **▶** or **⊙** (**SELECT**) to move to the third level.
- 5** Use **▲ / ▼** to select an option.
- 6** Press **MENU** to return to the previous menu or press **EXIT** on the remote control to return to TV viewing

#### **N**otes

- If the programme format is High Definition (16:9) and HDTV Receiver's resolution is 576p or 576i, the Aspect Ratio is set to Auto, Letter Box, or Pan & Scan.
- If the programme format is High Definition (16:9) and HDTV Receiver's resolution is 1080i or 720p, the Aspect Ratio is set to Auto, 4:3, 16:9, or Zoom.
- If you select "Auto", the aspect ratio will be changed by programme automatically.

#### **T**ip

- While watching TV, you can change the picture aspect ratio using **ARC** on the remote control. To view a high definition picture with 4:3 normal TV, use the **ARC** button on the remote control to change the wide mode (Auto, Letter Box, or Pan & Scan ).
- To view a high definition picture with wide (16:9) TV, use the **ARC** button on the remote control to change the wide mode in the cycle (Auto, 4:3, 16:9, or Zoom).
- To view a standard definition picture with wide (16:9) TV, use the **ARC** button on the remote control to change the wide mode in the cycle (Auto, 4:3, 16:9, or Zoom).

## Special Menu Options



### Clock Set

Enables the user to adjust the time zone. Normally, your clock is set using signals transmitted by DTV stations. Choosing your time zone sets the current time automatically.

- 1** Press **MENU** to display the on-screen menu.
- 2** Select the **SPECIAL** menu using **▲ / ▼** then press **⊙** (SELECT) or **▶**.
- 3** Use **▲ / ▼** to select the **Clock Set** option then press **▶** or **⊙** (SELECT) to move to the third level.
- 4** Use **▲ / ▼** to select **On** or **Off** then press **⊙** (SELECT).  
If you select **Off**, the clock is not set.
- 5** If you select **On**, use **▲ / ▼** to set **Time Zone**.
- 6** Press **MENU** to return to the previous menu or press **EXIT** on the remote control to return to TV viewing.

#### **N**ote

- There are cases where the TV station does not send, or sends wrong date and/or time information causing the HDTV Receiver to set an incorrect time.
- You have no way to manually set the clock.

### Caption

If the Caption option is set to On, Closed Caption is displayed when receiving TV programme with Closed Caption signal.

If the Caption option is set to Off, Closed Caption is not displayed.

#### **N**ote

Caption will appear only if provided by the broadcaster.

#### **T**ip

- If available, you can also select a closed caption while viewing TV, press **CC** button repeatedly on the remote control.
- If captions are available, the DTV caption icon (**CC**) appears on the programme information display, Programme Guide to indicate that you can select one of those caption options with the **CC** button.



## Lock (Parental Control) Menu Options

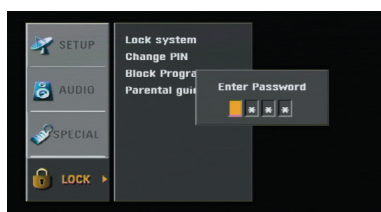

### Lock System

Allows you to set up specific programmes and ratings through blocking schemes. Also allows you to activate or disable all of the lock schemes previously set up. A PIN number is required to gain access to the LOCK menus. When the Lock System is set to Off, the Programme and Programme Rating are not effective.

- 1 Press MENU.**  
The main menu appears.
- 2 Use ▲ / ▼ to select the LOCK then press ► or Ⓞ (SELECT) to move to the second level.**

**When you have not entered a PIN number yet;**

Enter "0000" PIN number using the numbered buttons.

**When you have already entered a PIN number;**

Enter the 4-digit PIN number using the numbered buttons to confirm the personal 4-digit security PIN number.



- 3 Use ▲ / ▼ to select the Lock System option.**
- 4 Press ► or Ⓞ (SELECT) to move to the third level.**
- 5 Use ▲ / ▼ to select an option (On or Off).**
- 6 Press MENU to return to the previous menu or press EXIT on the remote control to return to TV viewing.**

### Change PIN

Changes the PIN number.

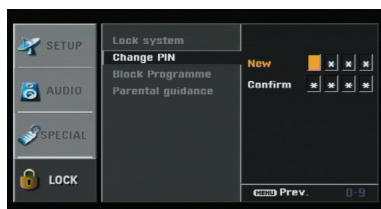

- 1 Follow steps 1-2 as shown above (Lock System).**
- 2 Use ▲ / ▼ to select the Change PIN option.**
- 3 Press ► or Ⓞ (SELECT) to move to the third level.**
- 4 Enter the new 4-digit code.**
- 5 Enter the same code again to verify.**
- 6 Press MENU to return to the previous menu or press EXIT on the remote control to return to TV viewing.**

#### **T** If you forget your PIN number

If you forget your PIN number, to clear the current PIN number, follow the procedure below.

1. Press MENU. The main menu appears.
2. Use ▲ / ▼ to select the LOCK then press ► or Ⓞ (SELECT) to move to the second level.
3. Use the Number buttons to enter the 4-digit number "7777".  
The 4-digit PIN number is cleared.
4. Enter a new PIN number using number buttons then enter it again to verify.



## Lock (Parental Control) Menu Options (Continued)

### Block Programme

Blocks any programme that you do not want to view or that you do not want your kids to watch. If you tune in a blocked programme, a black screen with a pop-up box will appear. This menu can override Programme Edit menu settings (page 18).

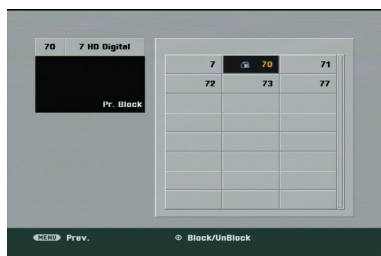
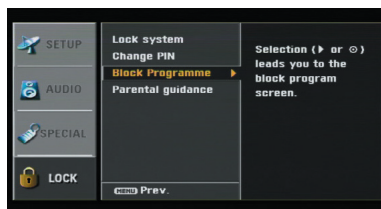

**Note:** If you access this menu when resolution is set to 576p, 720p, or 1080i, the VIDEO OUT and S-VIDEO OUT jacks' signals are blocked. Press EXIT button to restore the output signals.

- 1 Press MENU.**  
The main menu appears.
- 2 Use ▲ / ▼ to select the LOCK then press ► or ● (SELECT) to move to the second level.**

**When you have not entered a PIN number yet;**

Enter "0000" PIN number using the numbered buttons.

**When you have already entered a PIN;**

Enter the 4-digit PIN number using the numbered buttons to confirm the personal 4-digit security PIN number.

- 3 Use ▲ / ▼ to select the Block Programme then press ► or ● (SELECT).**  
The programme list screen appears.
- 4 Use ▲ / ▼ / ◀ / ▶ to a programme on the block programme menu.**
- 5 Press ● (SELECT) to block or unblock the programme on the block programme menu.**  
The  mark will appear to the right of the station name to indicate the blocked programme.
- 4 Repeat step 3 to block or unblock additional programmes in the programme list menu.**
- 5 Press MENU to return to the previous menu or press EXIT on the remote control to return to TV viewing.**

## Lock (Parental Control) Menu Options (Continued)

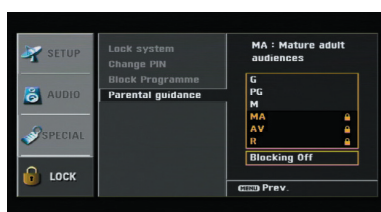

### Parental Guidance

You can set the ratings to block out all the programmes with ratings above a specified level.

- 1 Press MENU.**  
The main menu appears.
- 2 Use ▲ / ▼ to select the LOCK then press ► or Ⓞ (SELECT) to move to the second level.**

#### When you have not entered a PIN number yet;

Enter "0000" PIN number using the numbered buttons.

#### When you have already entered a PIN number;

Enter the 4-digit PIN number using the numbered buttons to confirm the personal 4-digit security PIN number.

- 3 Use ▲ / ▼ to select the Parent guidance option.**
- 4 Press ► or Ⓞ (SELECT) to move to the third level.**
- 4 Use ▲ / ▼ to select a rating.**

**G (General Audiences):** Content is not offensive to most viewers.

**PG (Parental Guidance Recommended):** Content is such that parents may not want their children to view the programme.

**M (Mature Audience 15+):** Mature Audience only. This programme is specifically designed to be viewed by adults and therefore may be unsuitable for children under 15.

**MA (Mature Adult Audience 15+):** Mature Adult only. Mature Audience Only. This programme is specifically designed to be viewed by adults and therefore may be unsuitable for children under 15.

**AV (Adult Audience strong violence 15+)**

**R (Restricted 18+):** Not for children under age 18. Strong elements of sex and/or violence.

**Blocking Off:** Cancel the blocking

- 5 Press MENU to return to the previous menu or press EXIT on the remote control to return to TV viewing.**

## Information Displays

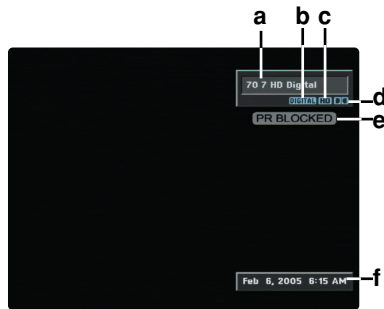

### Programme Banner Display

The Programme Banner appears whenever you tune to a new programme or press the **⊙** (SELECT) button on the remote control while viewing a programme.

#### 1 Press **⊙** (SELECT) while watching a programme

The Programme Banner appears on the TV screen (programme number, digital picture grade, audio, station name, and current time).

- The Programme Banner can be displayed on the TV screen for a moment.

- a) Programme number and Station name  
Displays the current programme number and station name.
- b) Displays Analog or Digital broadcasting.
- c) Digital Picture Grade  
Displays the digital picture grade such as HD (High Definition) or SD (Standard Definition).
- d) Audio Format type (Dolby Digital, MPEG I, MPEG II)  
Indicates audio track is Dolby Digital, MPEG I, or MPEG II.
- e) Block information  
Displays the block information such as no signal, rating blocked, programme blocked, audio only or scrambled.
- f) Date and Clock  
Displays the current date and clock.

#### 2 Press **⊙** (SELECT) again while the Programme Banner is displayed.

The Programme Banner disappears from the TV screen.

#### **N**otes

- Station name and clock are displayed only if they are set up by broadcast.
- The scrambled programme may not be able to see the programme.

## Information Displays (Continued)

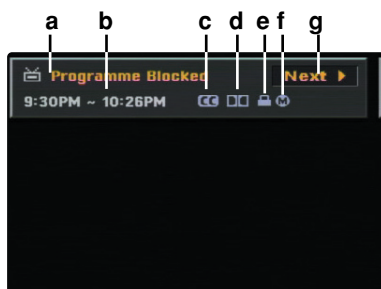

### Programme Information Display

The Programme Information appears whenever you press the INFO button on the remote control while viewing a programme.

#### 1 Press INFO while watching a programme

Programme Information appears on the TV screen.

- a) Programme title  
Indicates title of current programme.
- b) Start Time and End Time  
Displays the start time and end time for the current programme.
- c) DTV Caption Icon (CC)  
Indicates that the current programme contains digital closed caption data service.
- d) Audio Format type (Dolby Digital, MPEG I, MPEG II)  
Indicates audio track is Dolby Digital, MPEG I, or MPEG II.
- e) Block information  
Displays the block information such as no signal, rating blocked, programme blocked, audio only or scrambled.
- f) Content Advisory Icon (M)  
Content Advisory data is used for the parental guide control to block programmes that are beyond predefined rating criteria set by users. This icon means that the current programme contains content advisory data, and displays rating value of programme.
- g) Current or Next selection  
Indicates the information is for current or next program. Use ◀ / ▶ to change between Current or Next.

#### 2 Press INFO or EXIT while the Programme Information is displayed.

The Programme Information disappears from the TV screen.

#### Note

Station name and clock are displayed only if they are set up by broadcast.

## Programme Guide

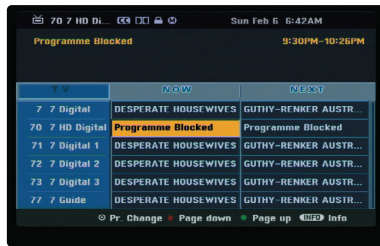

The Programme Guide contains schedule and programme information for all programmes. They also provide local over-the-air programmes information including conventional digital programmes. Use the Programme Guide to find programmes easily and conveniently and to view schedule and descriptive programme information for the programmes.

### **To Display the Programme Guide**

Press the GUIDE button on your remote control.

### **To Exit the Programme Guide**

Press the EXIT button to return to the last programme you tuned to.

### **To Navigate through programmes on the Guides**

Use ◀ / ▶ / ▲ / ▼ on your remote control to navigate the guide screen.

You can move faster through programmes by scrolling page-by-page with the RED or GREEN buttons on the remote control. Each button stroke scrolls one page up or down.

### **To Tune to another current programme**

Use ◀ / ▶ / ▲ / ▼ to select a current programme then press ● (SELECT). You can watch the programmed.

### **To Display the Full Information window**

You can view detail informations for the highlighted program. Press INFO to display detail information window. To exit the detail information window, press INFO again.

## Normal Operation

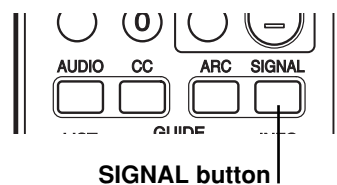
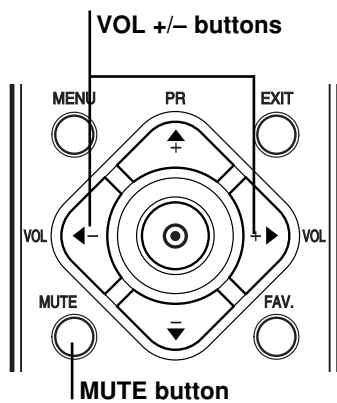
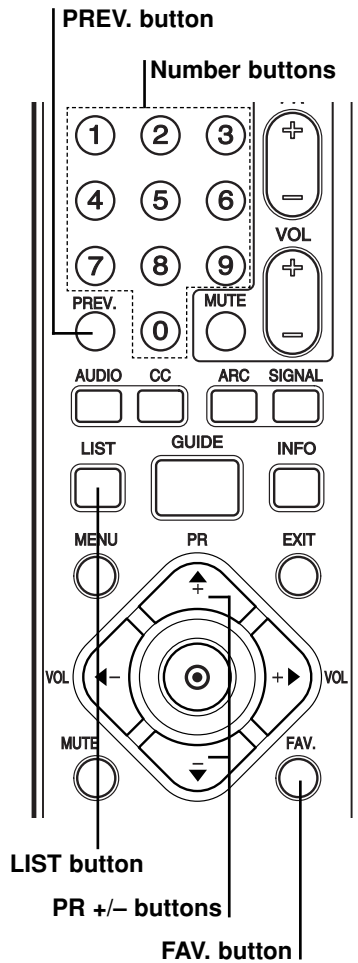

## Programme Selection

You can select a programme as shown below.

### Number buttons (on the remote control)

Use **Number (0-9)** buttons to select a programme directly.

### PREV. button (on the remote control)

Press to return to the previous programme you viewed. For example, if the DTV Receiver is tuned to programme 55 and then you change to programme 56, pressing **PREV.** will return to programme 55.

### FAV. button (on the remote control)

Press to scroll through your favorite programmes.

### PR +/- buttons (on the remote control) or ▲ / ▼ (on the front panel)

Use **PR +/-** on the remote control or **▲ / ▼** on the front panel to cycle the HDTV Receiver through the programmes in memory.

### LIST buttons

Press **LIST** on the remote control and Programme List appears. Use **▲ / ▼** to select a programme that you want to tune.

## Volume Adjustment

Adjusts the volume of analog audio out on HDTV Receiver. You must set Audio Variable to On in the Audio menu to use the Volume Adjustment. See page 21.

### VOL +/- buttons (on the remote control) or ◀ / ▶ (on the front panel)

Use **VOL +/-** on the remote control or **◀ / ▶** on the front panel to adjust the volume for analog audio out on the HDTV Receiver.

### MUTE (on the remote control)

Press **MUTE** to turn off the volume for analog/digital audio out on the HDTV Receiver.

### Notes

- Before setting Audio Variable to Off, make sure that you have turned down the TV's volume to the minimum. Otherwise, sudden high volume sound may cause hearing or speaker damage.
- The volume of digital audio out on HDTV Receiver can not be adjusted on the HDTV Receiver.

## Signal

Shows the signal strength bar for incoming signal to help you adjust the antenna to the correct position for your location. You can view the signal strength bar by pressing **SIGNAL** on the remote control.

## Teletext Operation

Teletext is an optional function, therefore only those with the teletext system can receive the teletext broadcast.

Teletext is a free service broadcast by some TV stations which gives up-to-the-minute information on news, weather, television programmes, share prices and many other topics.

The teletext decoder can support the SIMPLE systems. SIMPLE (standard teletext) consists of a number of pages which are selected by directly entering the corresponding page number.

### Teletext in Service

The HDTV Receiver gives you access to teletext which is greatly improved in various aspects such as text and graphics.

This teletext can be accessed by special teletext services and specific services which broadcast teletext.



**Note:** If you access this menu when resolution is set to 576p, 720p, or 1080i, the VIDEO OUT and S-VIDEO OUT jacks' signals are blocked. Press EXIT button to restore the output signals.

- 1** Press number or PR+/- buttons to select a service which broadcast teletext.
- 2** Press TEXT to access on the teletext.
- 3** Follow the indications on teletext and move onto the next step by pressing RED and GREEN buttons and so on.
- 4** Press TEXT or EXIT to switch off teletext and return to TV viewing.

### Teletext on/off

- 1** Press TEXT to switch to teletext.  
The initial page or last page appears on the screen. Two page numbers, TV station name, date and time are displayed on the screen headline. The first page number indicates your selection, while the second shows the current page displayed.
- 2** Press TEXT or EXIT to switch off teletext.

#### **N**ote

If your TV is in zoom mode, the Teletext menu screen may be cut off. In this case, set the TV's zoom mode to normal to display the menu screen properly.







### Page selection

- Enter the desired page number as a three digit number with the numbered buttons.  
If during selection you press a wrong number, you must complete the three digit number and then reenter the correct page number.
- Use PR (+/-) buttons to select the previous or next page.
- Use RED/GREEN buttons to move up and down pages.



## Teletext Operation (Continued)

### Special Teletext Functions

- MIX**  
  
**MIX button**  
Displays the teletext pages superimposed on the TV picture. To switch the TV picture off press this button again.
- CANCEL**  
  
**CANCEL button**  
Hides the teletext screen except page number.
- INDEX**  
  
**INDEX button**  
Selects the index page.
- SIZE**  
  
**SIZE button**  
Selects double height text. Press this button to enlarge the top half of the page. Press this button again to enlarge the bottom half of the page. Press this button again to return to the normal display.
- SUBPAGE**  
  
**SUBPAGE button**  
In teletext mode, press this button to select a sub page number. The sub page number is displayed at the bottom of the screen. To hold or change the sub page, press the number buttons. Press this button again to exit this function. (Refer to "Page selection" on page 30.)  
• **Use SUBPAGE button.**  
1) Press SUBPAGE. The sub page number is displayed at the bottom of the screen.  
2) Enter the desired page number as a 4-digit number using number buttons. (ex press 0 0 0 9 for page 09.)  
If you press a wrong number during selection, press SUBPAGE then enter the correct page number.
- FREEZE**  
  
**FREEZE button**  
Stops the automatic page change which will occur if a teletext page consists of 2 or more sub pages. When this button is pressed the stop symbol is displayed at the top left-hand corner of the screen and the automatic page change is inhibited. To continue press this button again.
- REVEAL**  
  
**REVEAL button**  
Press this button to display concealed information, such as solutions of riddles or puzzles. Press this button again to remove the information from the display.



## Programming the Remote Control to Operate the TV

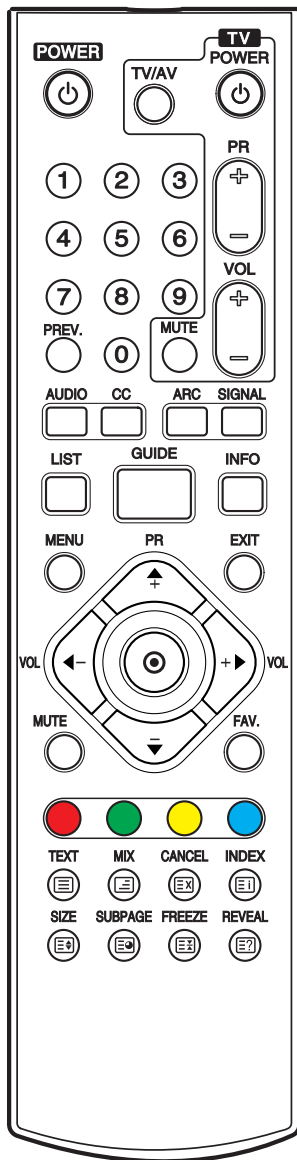

The HDTV Receiver remote control is a multi-brand or universal remote control that can be programmed to operate most remote-controllable TVs from other manufacturers.

### Note

The remote control may not be able to control all models of other brands.

#### 1 Test your remote control.

To find out whether your remote control can operate a TV without programming, turn on the TV and press the TV on the remote control while pointing at the TV. Use the TV POWER and TV PR +/- buttons to see if the TV responds properly. If not, the remote control requires programming.

#### 2 Turn on the TV to be programmed.

#### 3 Find the manufacturer code for your TV. (Refer to pages 34-35)

#### 4 While holding down TV POWER button, press the number buttons to select the manufacturer code for your TV.

#### 5 Test the remote control functions to see if the device responds properly. If not, repeat from step 3-4.

You can control your TV using the buttons below.

By pressing	You can
POWER	Turn the TV on or off.
TV/AV	Switch the TV's input source between the TV and other input sources.
PR +/-	Scans up or down through memorized programmes.
VOL +/-	Adjust the volume of the TV.
MUTE	Temporarily turns TV sound OFF, press again to restore.

## Remote Control Codes for TVs

BRANDS	CODES	BRANDS	CODES	BRANDS	CODES
ADMIRAL	137 204	ELBE	058 144 157 160	HITACHI	011 013 015 017
ADYSON	159 219		192 246		021 022 023 024
AKAI	009 010 108 132	ELBIT	108 248		028 029 030 035
	133 135 139 140	ELECTROVENDA	108		039 040 041 048
	156 174 175	ELEKTRONIKA	108		053 054 055 056
AKURA	064 086 108 110	ELIN	108		057 120 127 128
	155 171	ELITE	064 149		129 134 135 140
ALBA	009 060 064	ELMAN	144		143 145 147 151
ALLSTAR	108	ELTA	010 171		156 159 173 193
AMSTRAD	006 025 157	EMERSON	108 204		219
AMWAY	108	ESC	108	HYPER	009 159 163 171
ANITECH	010 049 108 185	ETRON	133	ICE	009 010 064 108
	219	EUROPHON	144 159		171
ANTECNO	064	EXPERT	089	IMPERIAL	043 049 108 139
ARC EN CIEL	173 179 239	FENNER	171		144 154 165 255
ASA	087 102 108 235	FERGUSON	078 079 080 160	INGERSOLL	171
	236		182 195 198 199	INNO HIT	159 189 237
			200 201 202	INTERBUY	010
ASBERG	185			INTERCORD	233
ASORA	171	FINLANDIA	194 195	INTERFUNK	108 109 113 130
ATLANTIC	089 197	FINLUX	008 087 102 104		133 134 135 137
AUDIOSONIC	085		105 107 108 140		141 146 147 148
AUTOVOX	159 163 197		144 159 161 174		165 179 210
BANK	232		189 235 236	INTERVISION	010 086 108 132
BEKO	045 085 086 108	FIRST-LINE	144		144 166
	250	FISHER	086 208 222 233	IRRADIO	163 235 237
BESTAR	086	FORMENTI	108 149	ITC	144 159
BLAUPUNKT	031 091 092 096	FRABA	108	ITS	009 010 064 171
	097 098 099 210	FRONTECH	136 171 220	ITT	141 151 186
	253	FUBA	073 109	JVC	009 169
BONDSTEC	163	FUJITSU GENERAL	088 159 197	KAIDO	136
BOSCH	210	FUNAI	010	KAPSCH	089 147 148 197
BRANDT	173 179 225 239	GALAXIS	108 185	KARCHER	084 108
ELECTRONIQUE		GALERIA	171	KATHREIN	109
BRIONVEGA	204	GBC	137 144 171	KAWA	009
BSR	144	GEC	011 108 129 147	KENDO	060 108 137 157
BUSH	009 136 139 144		159 189	KENNEDY	197
	232	GELOSO	064 137 144 164	KNEISSEL	108
CENTURY	165 204		171	KONKA	009
CGE	139 165 210	GENERAL	171	KORTING	086 204 209
CIE	025 108 170	GENERAL TECHNIC	171	KUBA	233
CLATRONIC	009 010 064 108	GOLDHAND	159 171	KUBA ELECTRONIC	233
	144 149 159 164	GOLDSTAR	038 050 108 110	KURA	134
	165 171 185		136 144 159 163	LENCO	108 170
CLARIVOX	033		166 171 191 219	LG	001(Default) 038
CONDOR	108 149 191		237		050 108 110 136
CONIC	219	GOODMANS	009 064 108 109		144 159 163 166
CONTEC	171 222		110 120 159 170		171 191 219 237
CONTINENTAL	173 179 225 239		171	LIESENKOTTER	108 210
EDISON		GORENJE	086	LIFETEC	010 064 108 170
COSMOS	108	GPM	010 064	LOEWE	109 113 204 205
CROSLEY	165 204	GRANADA	027 105 108 111	LOGIK	070 227
CROWN	084 085 086 108		121 134 140 159	LUMA	137 197
	144 171 185		162 167 187 194	LUXOR	102 104 132 133
CS-ELECTRONICS	064		195 238		134 135 138 140
DAEWOO	051 108 120 127	GRUNDIG	091 092 093 094		143 145 153 156
	170		095 097 098 100		174 186 237
DANSAI	010 219		101 172 232 238	M ELECTRONIC	103 104
DE GRAAF	108 134	HCM	010 108 159 171	MAGNADYNE	163 164 204
DECCA	070 108 159 161	HIFIVOX	173 179 239	MAGNAFON	199
	162 184 189 190	HINARI	010 064 108 133	MAGNASONIC	108
	206		171	MARANTZ	108
DECCAVIDEO	108	HIT	204	MARSHAL	064
DUAL	233			MATSUI	009 016 025 060
DUMONT	204				061 062 063 070
					108 131 136 152
					154 159 171 172

## Remote Control Codes for TVs (Continued)

BRANDS	CODES
MERRIT	132
METZ	047 092 097 098 100 101 108 204 207 254
mitsubishi	075 076 077 097 113 204 222 224 240
MIVAR	044 042 159 235
MNARTT	007
MTC	086 109 134
MULTITECH	136 159 171 185
MURPHY	232
NAONIS	137
NECKERMANN	037 059 060 092 098 100 101 108 109 113 115 118 119 134 135 137 143 157 159
NEI	064 108
NIKKAI	219
NIKKO	108
NOBLIKO	232 235
NOGAMATIC	173 179 239
NOKIA	014 019 032 102 103 104 108 132 133 134 135 138 140 141 145 146 147 148 156 174
NORDMENDE	129 173 179 180 181 193 195 225 226 228 239
NORMN	108
NOVA	087
OCEANIC	032 103 104 135 140 156
OKANO	108
ONWA	009 010 064
ORAVA	108
ORBITER	086
ORION	025 059 060 061 062 064 070 108 110 118 219
OSAKE	106
OTTO-VERSAND	002 005 009 014 059 060 081 082 083 085 092 097 098 100 101 108 109 111 113
PAEL	235
PANASONIC	002 003 005 167 168 229
PATHE CINEMA	144
PATHE MARCONI	173 179 225 239
PHILCO	090 108 139 144 148 165 204
PHILIPS	065 066 067 068 069 092 108 109 111 112 114 115 116 119 122 123 124 125 193 212 251 252
PIONEER	193
PRANDONI-PRINCE	137 235
PRIMA	219
PRO VISION	108

BRANDS	CODES
PROFEX	108 136 171
PROFITRONIC	108
QUELLE	002 010 014 019 025 059 060 072 084 086 087 088 092 097 098 100 101 102 175
RADIOLA	108
RADIOTONE	010 085 108 171
REDIFUSSION	187
REVOX	109
REX	088 089 137 157 158 164 197 246 247
RFT	064 085 135 204
RITAR	138
ROADSTAR	108
ROSITA	171
SABA	079 146 147 173 179 181 193 195 225 226 239
SAISHO	025 060 070 136 159
SAKIO	171
SALORA	019 032 103 104 132 133 134 135 137 138 140 142 143 145 150 156 174 237 241
SAMBERS	235
SAMSUNG	004 010 050 086 108 117 126 171 220 237
SANY	193
SANYO	014 018 019 020 032 034 071 086 087 189 218 221 222 223
SCHNEIDER	009 064 088 108 133 141 159 163 233
SEG	010 064 108 144 159 165 171 185 219
SEI-SINUDYNE	025 108 204 212
SELECO	088 089 137 157 197 222
SENTRA	064 133
SHARP	081 082 083 222
SHINTOM	108
SHINTOSHI	108
SHIVAKI	108
SIAREM	204
SIEMENS	092 096 097 098 100 101 108 210 218 219 221
SIESTA	085
SILVER	010 064
SINGER	108 164 204
SINUDYNE	118 131
SMARAGO	172
SOLAVOX	133
SONOLOR	140 156
SONTEC	108
SONY	072 074 211 212 213 214 215 216 217 222

BRANDS	CODES
SPECTRA	170
STARLITE	108 171
STARLUX	171
STERN	088 089 137 157 197
SUNSTAR	108 171
SUPERTECH	108 139 152 171
TADISTAR	108
TASHIKO	108 159 218
TEC	108 139 144 159 170 171
TECHLINE	185
TECHNISAT	108 165
TECNISON	108 171
TEKON	171
TELEAVIA	173 178 179 225 239
TELEFUNKEN	079 177 179 181 193 195 200 210
TELEOPTA	171
TELERNT	109
TELETECH	165 171
TELETEXT	115
TELETON	088
TELETON	089 134 159 197
TENSAI	064 108 144 149 171 191
TENSON	171
TESLA	204
THOMSON	052 078 079 134 173 178 179 181 193 195 225 239
THORN	011 014 016 018 026 028 066 072 075 087 097 102 108 116 135 141 145 146 160
THORN-FERGUSON	160 188 200 227
TOSHIBA	012 016 026 036 037 222 232
TOWADA	144 185
TRISTAR	010 064
TRIUMPH	025 219 236
UHER 089	108 109 149 185 197 233
ULTRAVOX	108 164 185 204
UNIVERSUM	174
UNIVOX	204
VESTEL	108
VIDEOSAT	165
VIDEOTON	178 193
VIDEOWAY	230
VISION	108 149
VOXSON	137 204
WALTHAM	178
WATSON	064 108 149 171
WEGA	208 222
WHITE	108 110 149
WESTINGHOUSE	
YOKO	010 064 108 136 144 159 164 170 171
ZANUSSI	137 197
ZENITH	231

## Troubleshooting

Check the following guide for the possible cause of a problem before contacting service.

Symptom	Solution(s)
HDTV Receiver does not turn on.	<ul style="list-style-type: none"><li>● Plug the power cord into a wall power outlet securely.</li></ul>
Fragmented picture and unclear sound.	<ul style="list-style-type: none"><li>● Check your antenna input, location, and signal strength.</li></ul>
No picture.	<ul style="list-style-type: none"><li>● Make sure the correct video display format is selected.</li><li>● Make sure that the right component type is selected.</li><li>● If HDTV Receiver is connected to your monitor or TV via the COMPONENT VIDEO jacks on the back panel, the Output Selection must be set to YPbPr (refer to Display Format Setup on page 16.). Otherwise, you will probably see an abnormal picture.</li><li>● If HDTV Receiver is connected to your monitor or TV via the RGB port on the back panel, Output Selection must be set to RGB (refer to Display Format Setup on page 16.). Otherwise, you may not be able to see a picture.</li><li>● Select the Auto Programme or Programme Edit functions if you have not already done so.</li><li>● Check to make sure all the cables are installed correctly and that the proper source is selected on your TV. For example, Video 1 or 2.</li><li>● The antenna signal strength may be low. Check the signal strength and adjust the antenna location and direction.</li><li>● Due to copyright restrictions, you may not be able to view some high definition programmes in the high definition format.</li><li>● For more information about connections, please refer to connections on pages 9-14.</li></ul>
Normal picture but no sound.	<ul style="list-style-type: none"><li>● Check volume levels.</li><li>● Make sure the TV is not muted.</li><li>● Check that the HDTV receiver is connected properly.</li></ul>
Picture is distorted.	<ul style="list-style-type: none"><li>● Make sure the proper format is selected.</li><li>● Make sure the proper aspect ratio is selected.</li><li>● Make sure the video output is connected to the TV.</li></ul>
The remote control does not work properly.	<ul style="list-style-type: none"><li>● Point the remote control on the remote sensor on the HDTV Receiver.</li><li>● Operate the remote control within 7 m.</li><li>● Remove possible obstacles blocking the signal.</li><li>● Replace exhausted batteries with new ones.</li></ul>

### Reset the HDTV Receiver

The HDTV Receiver is not operating normally. You can reset the HDTV Receiver as follows:

Unplug the power cord, wait at least 30 seconds, and then plug it in again.

## Specifications

<b>Television System</b>		DVB-T Australian Standard Compliant
<b>Frequency Range</b>		VHF : 177.5 to 226.5 MHz UHF : 529.5 to 816.5 MHz
<b>Input/Output</b>	<b>RF Inputs</b>	ANT IN (1) 75 ohm unbalanced
	<b>ANT Loop Out</b>	Out To TV (1)
	<b>DVI Output</b>	DVI-HDTV Out (1), DVI-D Single Link connector 1080i, 720p, 576p digital RGB
	<b>Component Video Output</b>	Component Out (1 Set), Typical RCA type Jack connectors 1080i, 720p, 576p, 576i YPbPr
	<b>RGB Output</b>	RGB Out (1), 15-pin connector 1080i, 720p, 576p RGB
	<b>S-Video Output</b>	S-Video Out (1), 4-pin Mini-DIN 576i Y/C
	<b>Video Output</b>	Video Out (1), Typical RCA type Jack connector 576i Composite
	<b>Digital Audio Output</b>	Coaxial, Optical (Dolby Digital, PCM output)
	<b>Analog Audio Output</b>	Audio Out (2) (Variable Output Level)
	<b>Authorized Service Port</b>	9-pin Serial Port (1)
<b>Dimension (W x H X D)</b>		360 x 60 x 262 mm
<b>Weight</b>		3.5 kg
<b>Power Requirements</b>		AC 110-240V, 50/60Hz
<b>Power Consumption</b>		15W
<b>Environment</b>	<b>Humidity</b>	0 to 99 percent non condensing
	<b>Storage Temperature</b>	-20 to 60 degrees Celsius
	<b>Operating Temperature</b>	0 to 40 degrees Celsius
<b>Accessories</b>	RF cable . . . . .1	
	Video and Audio (L/R) cable . . . . .1	
	Component (YPbPr) cable . . . . .1	
	Remote Control . . . . .1	
	Batteries (size AAA) . . . . .2	

REFERENCE

- Design and specifications are subject to change without prior notice.



P/NO : 3834RB0002J